

WYMIAROWANIE

Wymiary poziome, pionowe, równoległe, bazowe, szeregowe, skośne, kątowe, promieniowe, środek

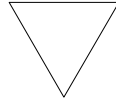
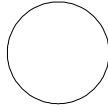
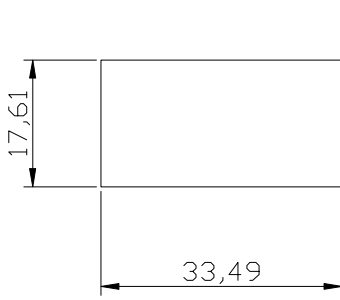

Wskazówki:
Wybierz element do wymiarowania
Wskaż punkty

Wskazówki: Zastosuj różne opcje wymiarowania kąta

Wymiary bazowe

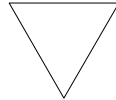
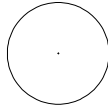
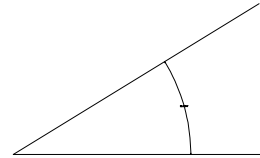
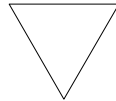
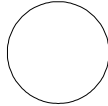

środek

Wymiary szeregowe

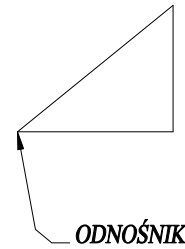
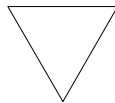
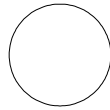

ODNOŚNIK

WYMIARY OBRÓCONE _ROTated

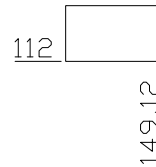

WYMIARY WSPÓLRZĘDNOŚCIOWE

Założ nowe style wymiarowania by osiągnąć różne wersje jak poniżej

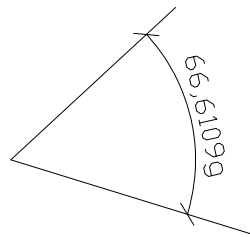
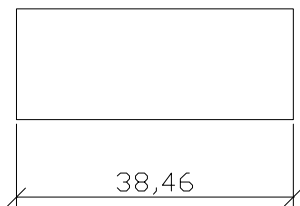

Dane do zadań z wymiarowania